

SBK-1600G BACK MACHINE

THERE IS A RISK ASSUMED BY INDIVIDUALS WHO USE THIS TYPE OF EQUIPMENT. TO MINIMIZE RISK, YOU MUST FOLLOW THESE RULES:

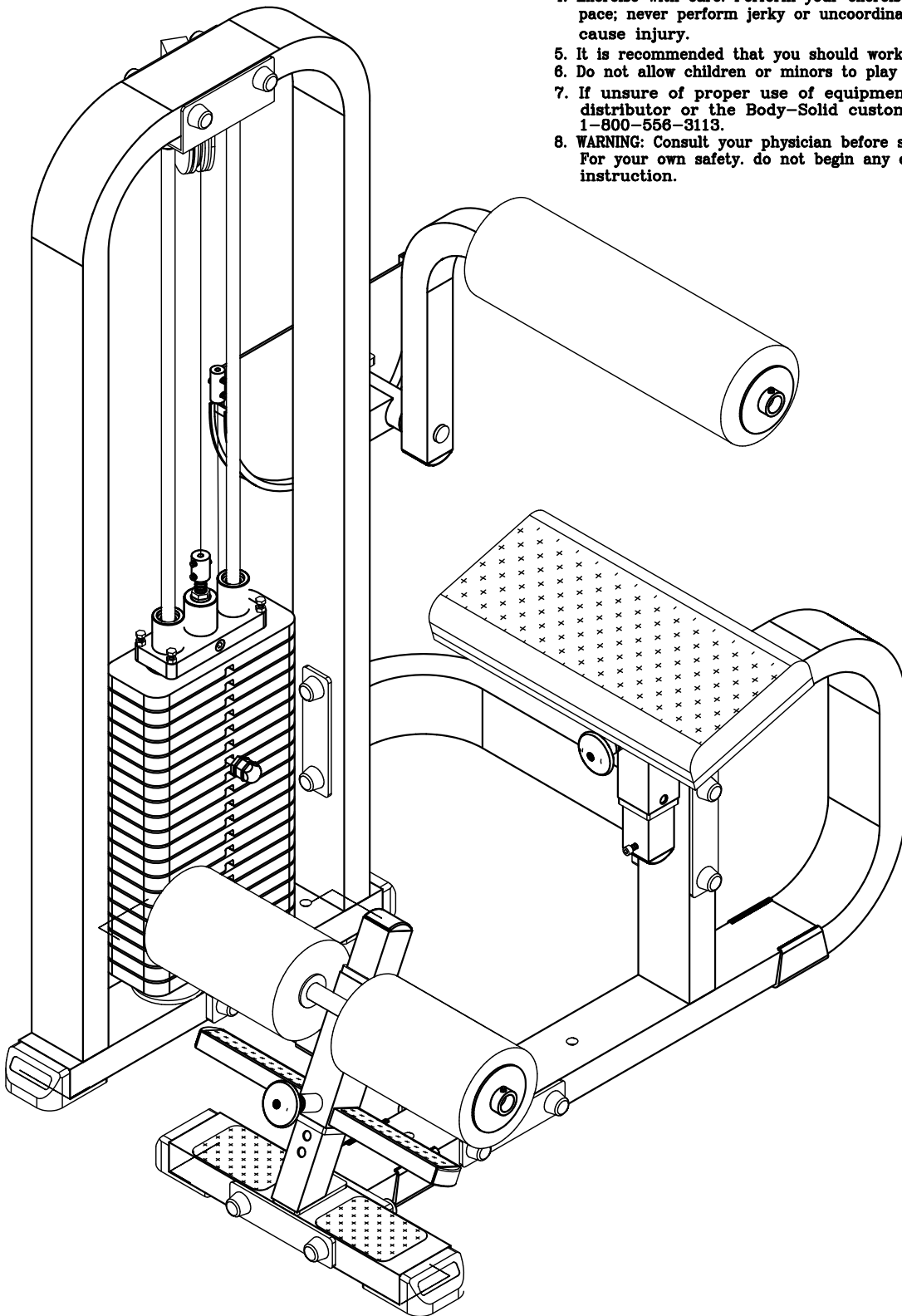









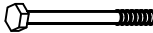
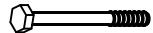
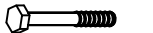

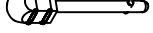

1. Inspect equipment before each workout. Check that all nuts, bolts, screws and pop pins are in place and fully tightened. Also, before use, check cables for signs of wear. Replace all worn parts immediately. Never use machine if any parts are damaged or missing. Failure to follow these rules may result in serious injury.
2. Keep clear of the cables and all moving parts when the machine is in use.
3. Always make sure all Snap Links are closed when doing any cable/pulley exercises.
4. Exercise with care. Perform your exercises at a smooth moderate pace; never perform jerky or uncoordinated movements that may cause injury.
5. It is recommended that you should workout with a training partner.
6. Do not allow children or minors to play on or around this equipment.
7. If unsure of proper use of equipment, call your local Body-Solid distributor or the Body-Solid customer service department at 1-800-556-3113.
8. **WARNING:** Consult your physician before starting your exercise program. For your own safety, do not begin any exercise program without proper instruction.

RAL2-11-98



VERSION 1105

SBK-1600G HARDWARE ILLUSTRATION SHEET

	Qty.		Qty.
 A1. 1/2"X5 1/2" HEX HEAD BOLT	[8PCS]	D11. STEEL CABLE	[1PCS]
 A2. 1/2"X5" HEX HEAD BOLT	[2PCS]	D12. ø4 1/2" PULLEY (9213-010)	[1PCS]
 A3. 1/2"X3 1/2" HEX HEAD BOLT	[2PCS]	D13. ø3" NYLON WASHER (9214-008)	[6PCS]
 A4. 1/2"X2 1/4" HEX HEAD BOLT	[2PCS]	D14. 1"X2" END CAP (9211-086)	[2PCS]
 A5. 5/16"X1 1/4" HEX HEAD BOLT	[4PCS]	D15. 2"X4" FOOT CAP (9211-028)	[5PCS]
 A6. 7/16"X1 1/2" ROUND BOLT	[1PCS]	D16. 38X195 NO-SLIP TAPE (9310-030)	[2PCS]
 A7. 5/16"X3/8" SET SCREW	[3PCS]	D17. ø150X250 FOAM ROLLER (9161-016)	[2PCS]
 A8. 5/8" ROUND BOLT	[1PCS]	D18. ø150X500 FOAM ROLLER (9161-017)	[1PCS]
 A9. 10LB BALL PIN	[1PCS]	D19. WEIGHT SELECTOR BAR (8220-060)	[1PCS]
 B1. 1/2" NYLON LOCK NUT	[14PCS]	D21. ø5/8" ROUND END CAP (9211-015)	[6PCS]
 B2. 5/8" LOCK NUT	[1PCS]	D22. ø1" SHAFT COLLAR (8130-024)	[3PCS]
 C1. 1/2" ROUND END CAP WASHER	[28PCS]		
 C2. ø1" CHROME WASHER	[3PCS]		
 C3. 5/16" (I.D)WASHER	[4PCS]		
 C4. 5/16" SPRING WASHER	[4PCS]		
 C5. 5/8" SPRING WASHER	[1PCS]		
D1. 1/2" BOLT CAP	[28PCS]		
D2. 50X50X1.8t END CAP (9211-087)	[3PCS]		
D3. 2"X2" NYLON BUSHING (9211-033)	[4PCS]		
D4. ø4" RUBBER DONUT (9310-017)	[2PCS]		
D5. ø3/4" SHAFT COLLAR (9211-046)	[2PCS]		
D6. ø6" PULLEY (9213-009)	[1PCS]		
D7. 2"X4" RUBBER BUSHING (9212-009)	[3PCS]		
D8. 95X140 NO-SLIP TAPE (9310-035)	[2PCS]		
D9. CHROME TOP PLATE (8400-002)	[1PCS]		

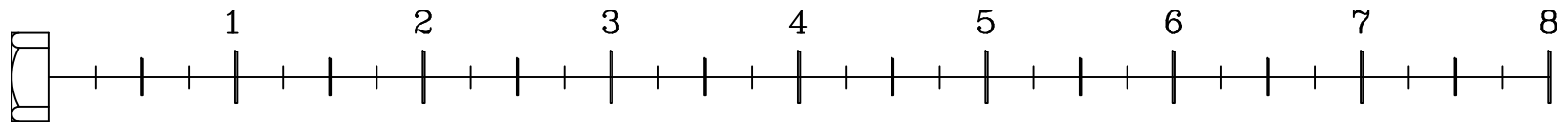
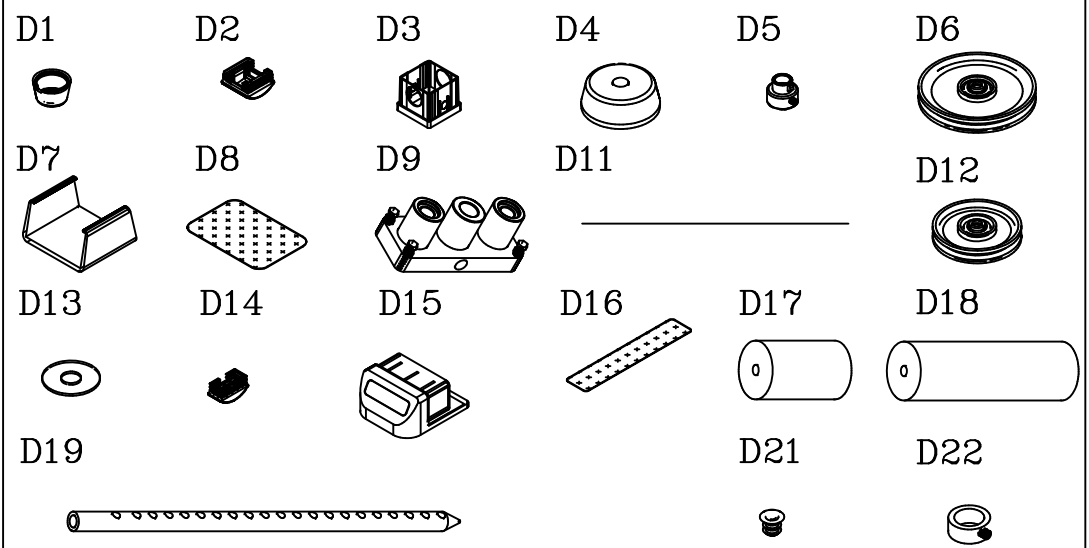

SBK-1600G PARTS ILLUSTRATION SHEET

A [1PCS] WEIGHT STACK FRAME

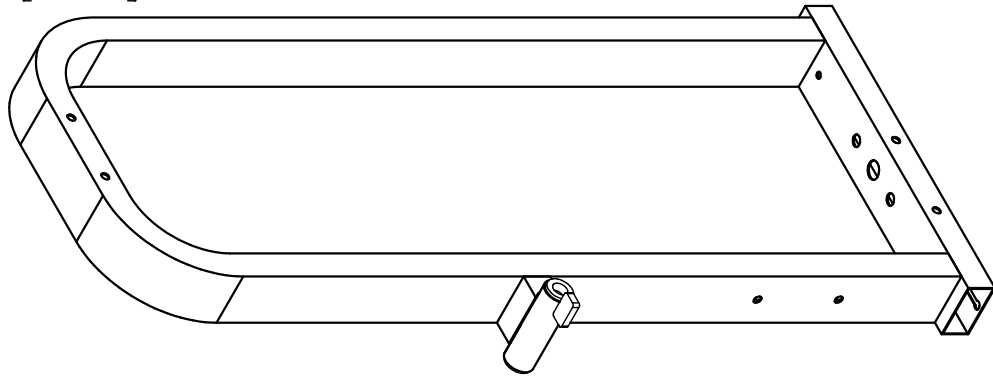

D [1PCS] MAIN BODY FRAME

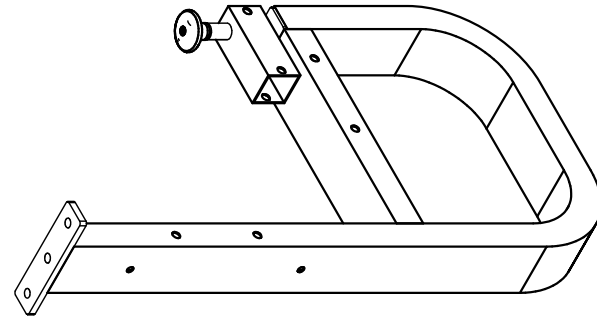

B [1PCS] BOTTOM SUPPORT FRAME

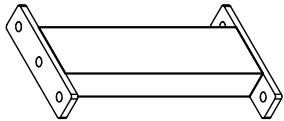

E [1PCS] MIDDLE SUPPORT FRAME

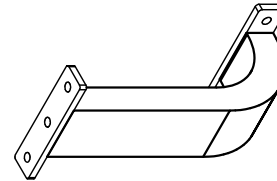

F [1PCS] FRONT FOOT FRAME

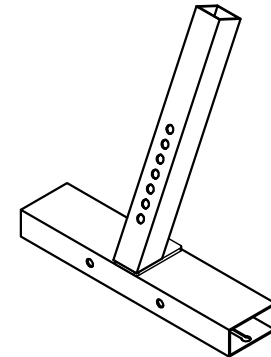

C [1PCS] BOTTOM PULLEY FRAME

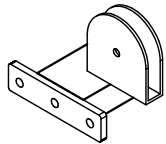

G [1PCS] LEG HOLD FRAME

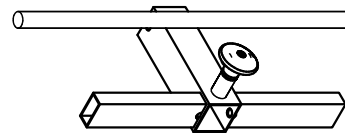

H [1PCS] PIVOT ARM

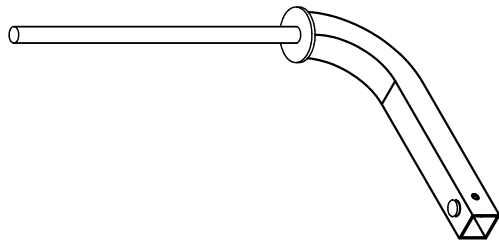

I [1PCS] CAM WHEEL

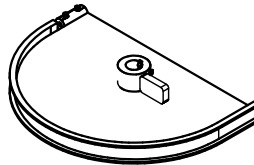

J [1PCS] SEAT FRAME

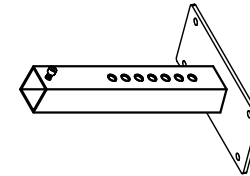

O [1PCS] TOP PULLEY FRAME

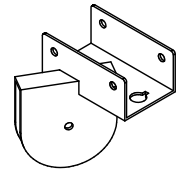

M [2PCS] CHROME GUIDE ROD
8280-001

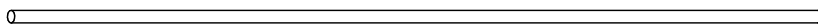

K [4PCS]
8312-077

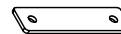

P [1PCS] SEAT PAD
9121-019

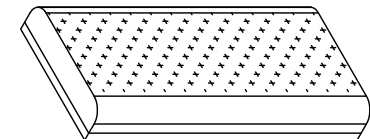

SBK-1600G

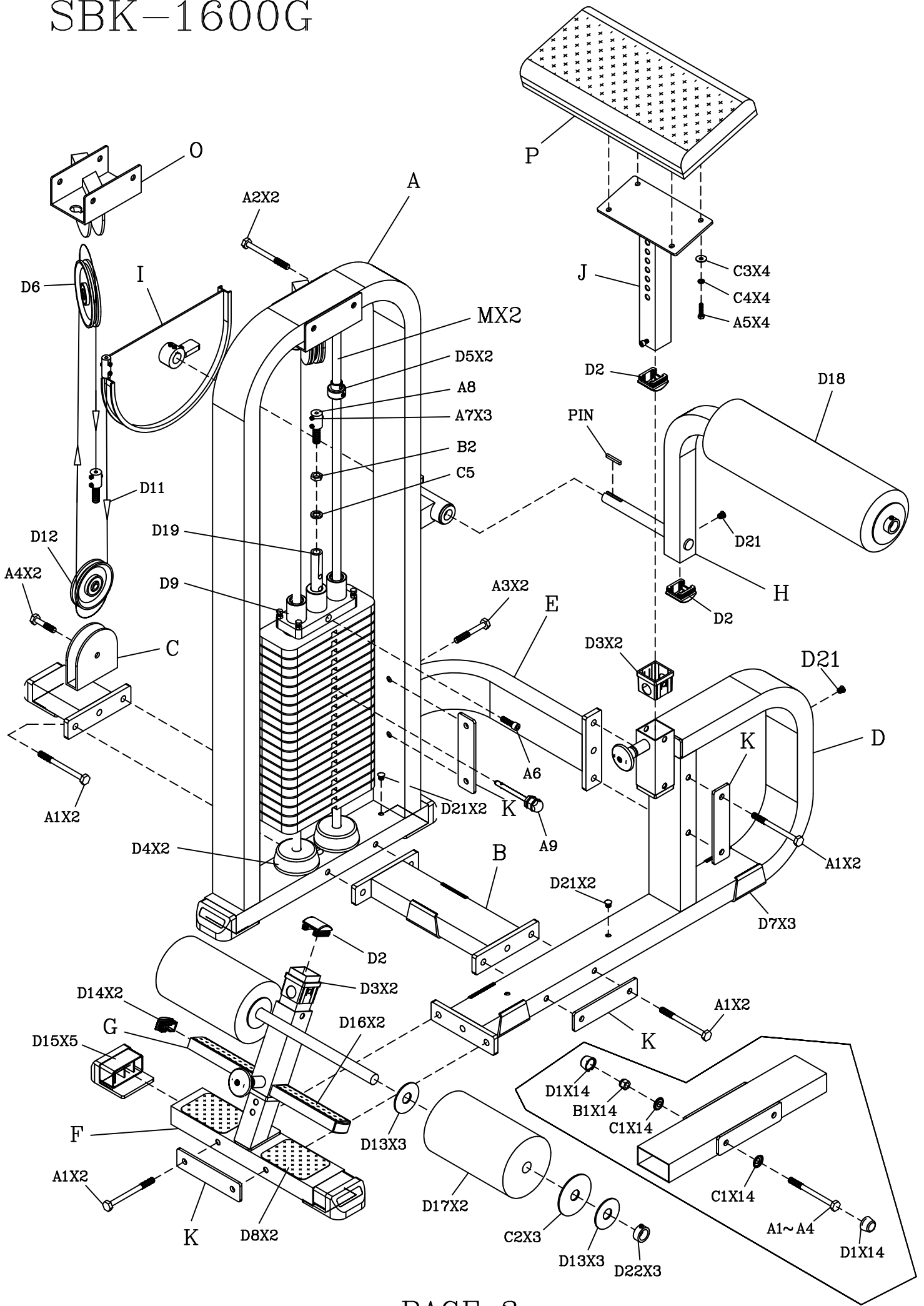

SBK-1600G BACK MACHING

ASSEMBLY STEPS

STEP-1

NOTE: DO NOT TIGHTEN NUTS AND BOLTS SECURLY UNTIL YOU HAVE COMPLETED ALL ASSEMBLY STEPS.

- Attach A Weight Stack Frame and C Bottom Pulley Frame to B Bottom Support Frame.
- Attach D Main Body Frame to B Bottom Support Frame.
- Attach F Front Foot Frame to D Main Body Frame.
- Attach E Middle Support Frame to A Weight Stack Frame and D Main Body Frame.
- Slide H Pivot Arm into A Weight Stack Frame.
- Attach I Cam Wheel to H Pivot Arm using Cam Pin.

STEP-2

- Attach M Chrome Guide Rods and D4 Rubber Donuts to A Weight Stack Frame.
- Slide on Weight Stack and D9 Chrome Top Plate.
- Attach O Top Pulley Frame to A Weight Stack Frame and Attach D5 Shaft Collar.
- Attach P Seat Pad to J Seat Frame.
- Slide J Seat Frame into D Main Body Frame.

CAUTION: DO NOT OVERTIGHTEN PAD BOLTS.
OVERTIGHTENING WILL STRIP
T-NUTS IN THE WOOD.

STEP-3

- Attach Foot Rollers and Back Roller.
- Attach Pulleys and Cables as shown.
- Attach End Caps and No-Slip Tape.
- TIGHTEN ALL NUTS AND BOLTS SECURELY.
- Attach Bolt Caps.

SAFETY RULES

1. Periodically check that all nuts,bolts and screws are fully tightened on your BACK MACHINE.
2. Exercise with care. Perform your exercises at a smooth moderate pace; never perform jerky or uncoordinated movements that may cause injury.
3. It is recommended that you should workout with a training partner.
4. Warning: CONSULT YOUR PHYSICIAN BEFORE STARTING YOUR EXERCISE PROGRAM. IT IS ADVISABLE TO HAVE A PHYSICAL EXAMINATION BEFORE YOU ENTER ANY EXERCISE PROGRAM. FOR YOUR OWN SAFETY, DO NOT BEGIN ANY EXERCISE WITHOUT PROPER INSTRUCTION.

SBK-1600G BACK MACHINE

